

IP 67
ACCORDING TO
EN 60529:1991+A1:2001
IEC 60529:2001

UL US
E 187490

RoHS
compliant

Pb
lead-free

SPECIFICATIONS

CONTACT RATING: Dependent upon contact material See page 17.

MECHANICAL LIFE: 30,000 make-and-break cycles.

CONTACT RESISTANCE: 10 mΩ max. initial @ 2-4VDC
100mA for both silver and gold plated contacts.

INSULATION RESISTANCE: 1,000 MΩ min.

DIELECTRIC STRENGTH: 1,000 Vrms min. @sea level.

OPERATING TEMPERATURE: -30°C to 85°C.

MATERIALS

CASE & BUSHING: Glass filled nylon 6/6, flame retardant, heat stabilized (UL94v-0).

ACTUATOR: Brass, chrome plated with internal, O-ring seal standard.

SWITCH SUPPORT: Brass or steel, tin plated.

SWITCH SUPPORT RETAINER: Stainless steel.

CONTACT / TERMINALS: Copper alloy, with Silver or gold plated.
(See Page 17)

HOW TO ORDER

MODEL NO.	ACTUATOR	BUSHING	TERMINATIONS	TERMINAL MATERIAL	SEAL	RoHS SOLDERING
<div style="display: flex; justify-content: space-between;"> <div style="width: 20%;"> <p>Model NO.</p> <p>1AS1 SP On-None-On</p> <p>1AS2 SP On-None-Mom.</p> <p>1AS3 SP On-Off-On</p> <p>1AS4 SP Mom.-Off-Mom.</p> <p>1AS5 SP On-Off -Mom.</p> <p>1AD1 DP On-None-On</p> <p>1AD2 DP On-None-Mom.</p> <p>1AD3 DP On-Off-On</p> <p>1AD4 DP Mom.-Off-Mom.</p> <p>1AD5 DP On-Off-Mom.</p> <p>1AD6 DP On-On-On</p> <p>1AD7 DP Mom.-On-Mom.</p> <p>1AD8 DP On-On-Mom.</p> <p>1A31 3P On-None-On</p> <p>1A32 3P On-None-Mom.</p> <p>1A33 3P On-Off-On</p> <p>1A34 3P Mom.-Off-Mom.</p> <p>1A35 3P On-Off-Mom.</p> </div> <div style="width: 20%;"> <p>Actuator</p> <p>T1 12.70 high</p> <p>T2 7.62 high</p> <p>TA Plastic, anti-static, black 12.70 high</p> <p>TB Plastic, anti-static, black 7.62 high</p> <p>TC Plastic, anti-static, silver 12.70 high</p> </div> <div style="width: 20%;"> <p>Bushing</p> <p>B1 8.89 high</p> <p>B4 6.10 high</p> </div> <div style="width: 20%;"> <p>Terminations</p> <p>M1 Solder Lug</p> <p>M2 PC thru-hole</p> <p>M51 18.70 high, wire wrap</p> <p>M52 24.20 high, wire wrap</p> <p>M53 10.55 high, wire wrap</p> <p>M54 26.97 high, wire wrap</p> <p>M6 Right angle, PC thru-hole</p> <p>M6N Right angle, snap-in, PC thru-hole</p> <p>M7 Vertical right angle, PC thru-hole</p> <p>VS2 11.68 high, V-bracket</p> <p>V2N 11.68 high, snap-in V-bracket</p> <p>VS3 16.00 high, V-bracket</p> </div> <div style="width: 20%;"> <p>Terminal material</p> <p>Q Gold flash over silver</p> <p>R Gold</p> <p>G Gold, pure-tin</p> <p>S Gold flash over silver, pure-tin</p> <p>C Gold over silver</p> <p>K Gold over silver, pure-tin</p> </div> <div style="width: 20%;"> <p>Seal</p> <p>E EPOXY (std)</p> </div> <div style="width: 20%;"> <p>RoHS soldering</p> <p><input type="checkbox"/> RoHS Compliant</p> <p>S RoHS & Lead Free</p> <p>F Halogen Free+RoHS</p> </div> </div>						



SWITCH FUNCTION

NO. POLES	UL/CSA MODEL NO.	MODEL NO.	SWITCH FUNCTION			CONNECTED TERMINALS / SCHEMATIC		
			POS.1	POS.2	POS.3	POS.1	POS.2	POS.3
SP	Q11A11	1AS1	ON	NONE	ON			
	Q11A12	1AS2	ON	NONE	MOM			
	Q11A13	1AS3	ON	OFF	ON			
	Q11A14	1AS4	MOM	OFF	MOM			
	Q11A15	1AS5	ON	OFF	MOM			
DP	Q11A21	1AD1	ON	NONE	ON			
	Q11A22	1AD2	ON	NONE	MOM			
	Q11A23	1AD3	ON	OFF	ON			
	Q11A24	1AD4	MOM	OFF	MOM			
	Q11A25	1AD5	ON	OFF	MOM			
	▲ Q11A27	1AD7	MOM	ON	MOM			
	▲ Q11A28	1AD8	ON	ON	MOM			
	3P	Q11A31	1A31	ON	NONE		ON	
Q11A32		1A32	ON	NONE	MOM			
Q11A33		1A33	ON	OFF	ON			
Q11A34		1A34	MOM	OFF	MOM			
Q11A35		1A35	ON	OFF	MOM			

MOM=MOMENTARY

▲ Please check the availability in advance before order

POLE OPTIONS

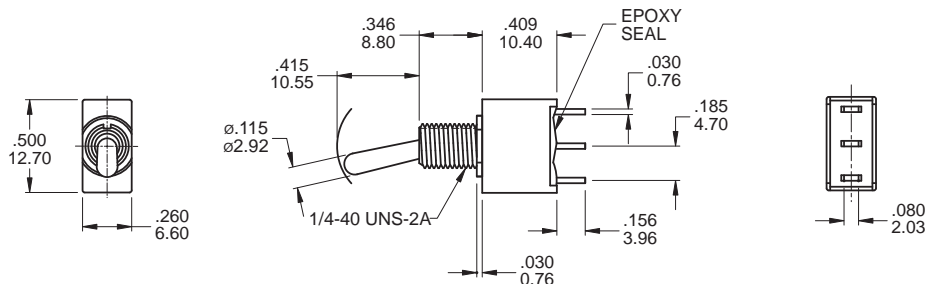

SPDT

Part No. Shown : 1AS1T1B1M1QE

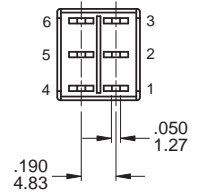
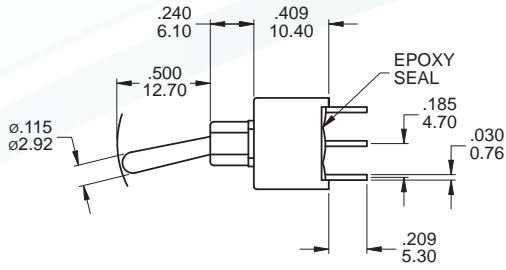
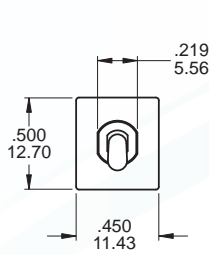

DPDT

Part No. Shown : 1AD1T1B4M2QE

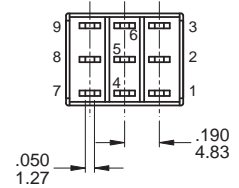
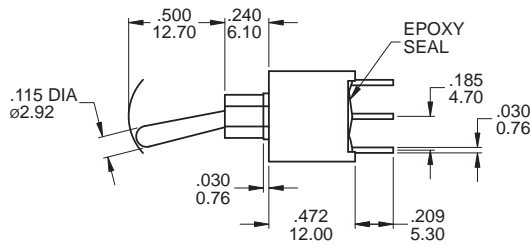
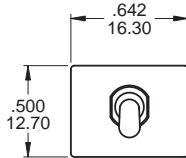

3PDT

Part No. Shown : 1A31T1B4M2QE

ACTUATOR OPTIONS

Actuator shown with standard B4 Bushing,
Subtract .085 (2.15) for B1 bushing.

T1

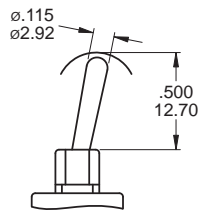

Standard with
M1, M2 terminations.

T2

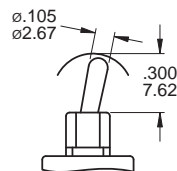

Standard with
M6, M7, VS2-3 terminations.

TA

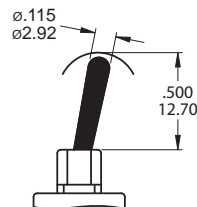

ESD

PLASTIC ACTUATOR
(TC anti-static , silver)

TB

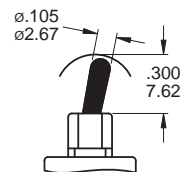

BUSHING OPTIONS

B1

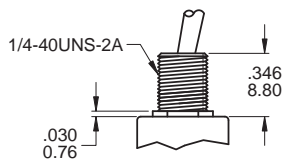

Std for M1

B4

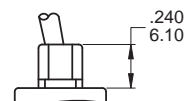

Std for M2, M6, M7, VS termination

TERMINATION OPTIONS

M1 Solder lug

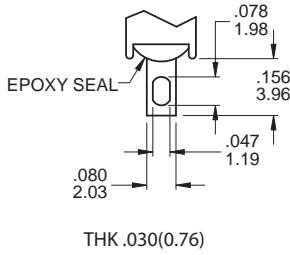

M2 PC Thru-hole

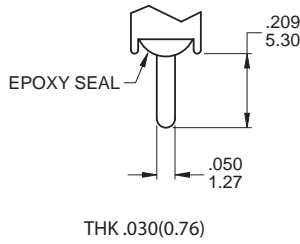

M3 Quick connect

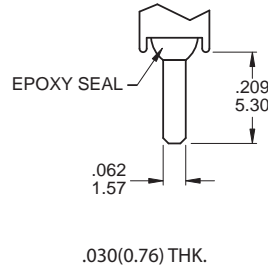

M5 Wire Wrap

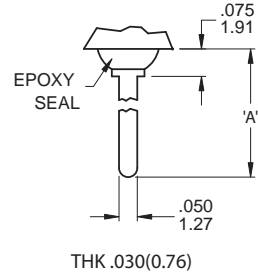

OTHER TERMINATION OPTIONS

- M6** RIGHT ANGLE P.C. MOUNT
- M7** RIGHT ANGLE P.C. MOUNT
- VS2** VERTICAL BRACKET P.C. MOUNT
- VS3** VERTICAL BRACKET P.C. MOUNT

OPTION CODE	DIM. 'A'
M5-1	.736 (18.70)
M5-2	.953 (24.20)
M5-3	.415 (10.55)
M5-4	1.062 (26.97)

M6

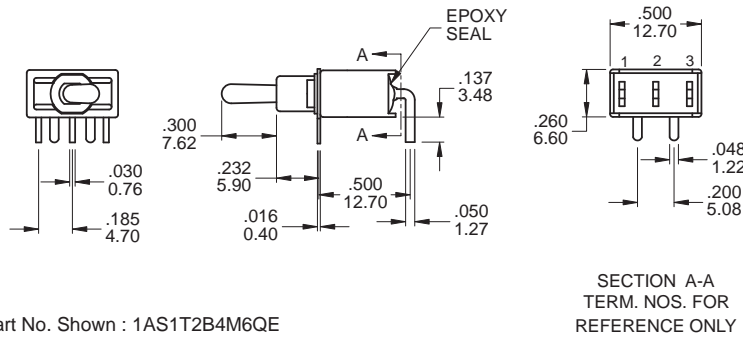

P.C. MOUNTING

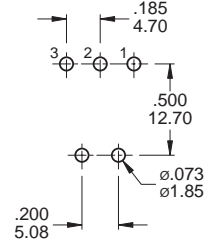

SPDT

Part No. Shown : 1AS1T2B4M6QE

M6

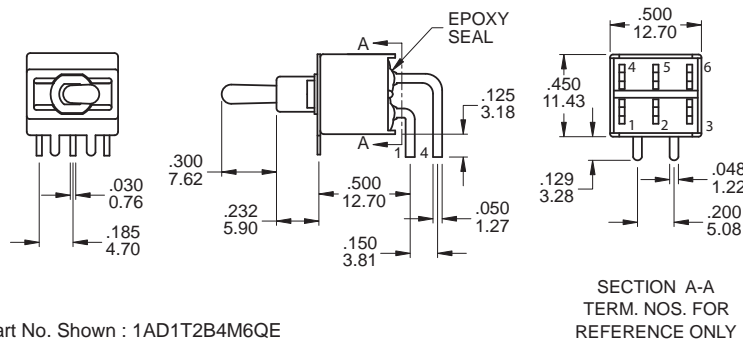

P.C. MOUNTING

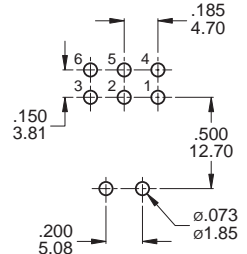

DPDT

Part No. Shown : 1AD1T2B4M6QE

M7

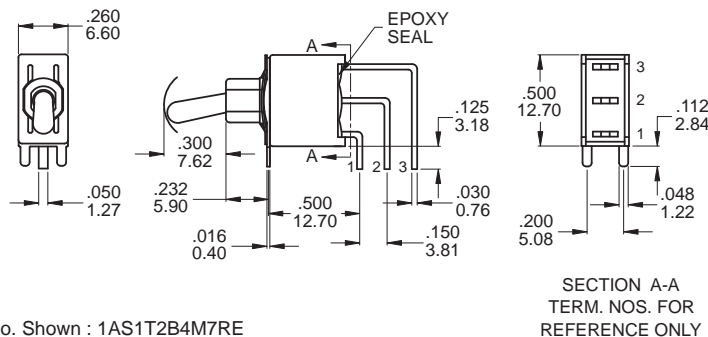
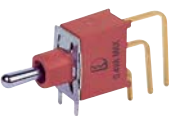

P.C. MOUNTING

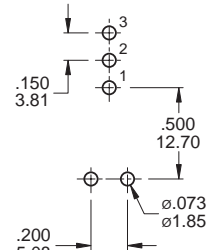

SPDT

Part No. Shown : 1AS1T2B4M7RE



M7

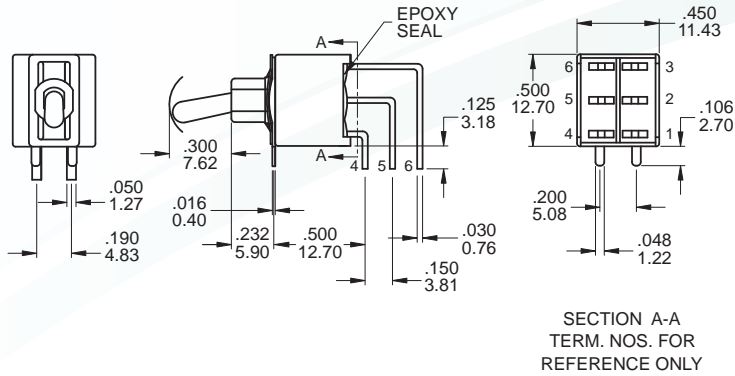

P.C. MOUNTING

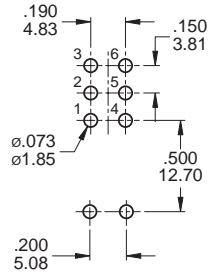

DPDT

Part No. Shown : 1AD1T2B4M7RE

M7

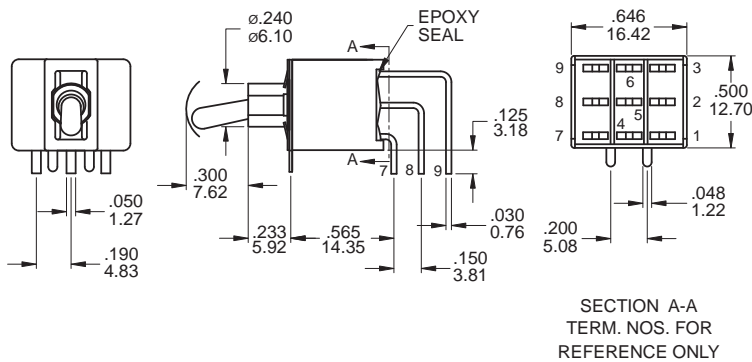

P.C. MOUNTING

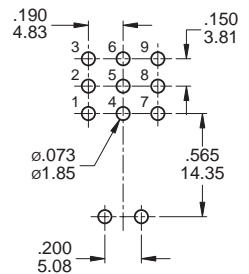

3PDT

Part No. Shown : 1A31T2B4M7QE

VS2 - VS3

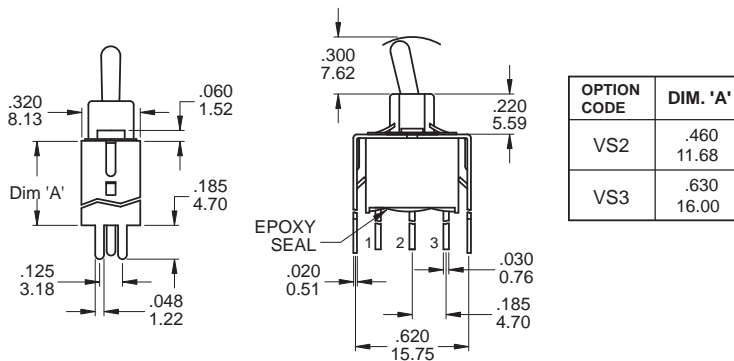

P.C. MOUNTING

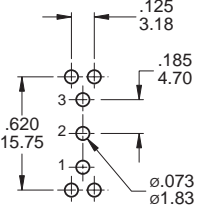

SPDT

Part No. Shown : 1AS1T2B4VS2QE

VS2 - VS3

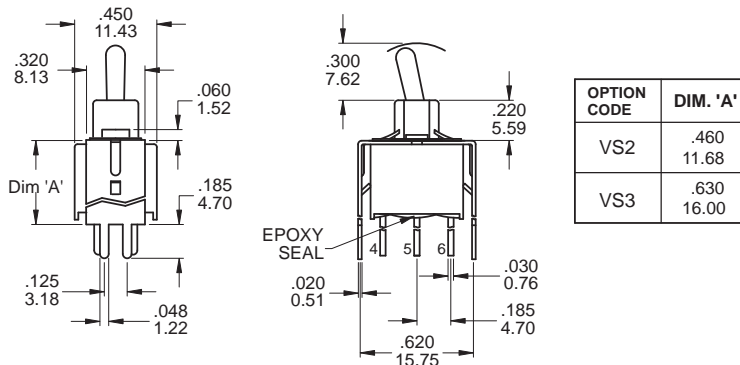

P.C. MOUNTING

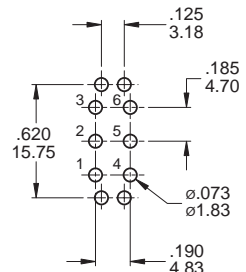

DPDT

Part No. Shown : 1AD1T2B4VS2QE

VS2 - VS3

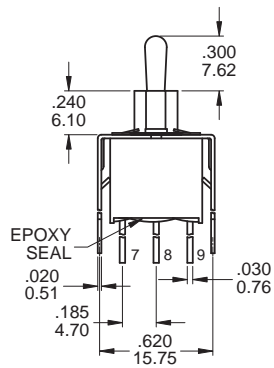
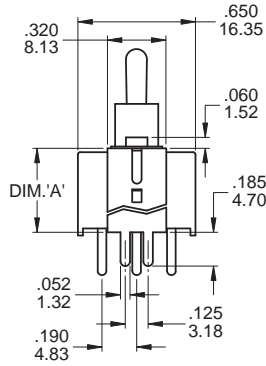

OPTION CODE	DIM. 'A'
VS2	.460 11.68
VS3	.630 16.00

P.C. MOUNTING

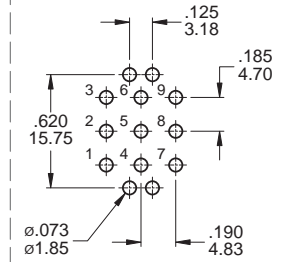

3PDT

Part No. Shown : 1A31T2B4VS2QE

SNAP-IN TERMINATION OPTIONS

M6N

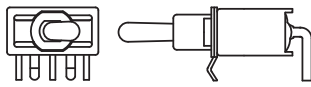

M7N

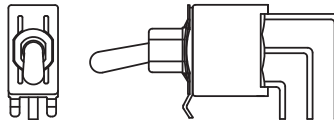

V2N

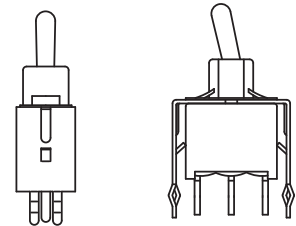

HARDWARE

1/4 NUT

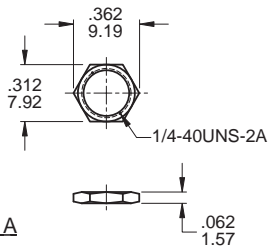

LOCKING RING

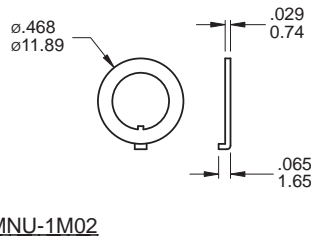

LOCK WASHER

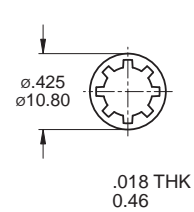

CONTACT MATERIAL OPTIONS

	CONTACT PLATING	TERMINAL PLATING	RATINGS
Q	Silver	Q = Gold flash over silver	5 Amps with resistant load @ 120VAC or 28VDC 2 Amps with resistant load @ 250VAC
S		S = Gold flash over silver,pure - tin	
C	Gold over Silver	C = Gold over silver	
K		K = Gold over silver,pure - tin	
R	Gold	R = Gold	0.4 Volt - Amps (VA) max. @ 20V max. (AC or DC)
G		G = Gold,pure - tin	

SOLDERING PROCESSES

MANUAL SOLDERING: Use soldering iron of 30 watts, controlled at 350°C approximately 5 seconds while applying solder.

WAVE SOLDERING: Recommended Soldering Temperature: 260 ± 5°C

Duration of Solder Immersion: Max 5 sec. (PCB is 1.6mm in thickness)